

CNE Series

Sensor connector

NEW

■ Features

- **Wire mount plug/socket**
 - Compact and highly reliable of pressure welding connector
 - Enables to connect wires as wire mount plug/socket
 - Different 9 colors of cover by wire diameter
 - Visible wiring status with translucent cover
- **Board mount socket**
 - Enables to insert 4EA, 2EA, or 1EA wire mount plugs
 - Contact placed in mold against electric shock and short-circuit
 - Mountable on board closely
- **Commons**
 - Significantly reduces connection time and effort
 - Wide products range for various wires
 - Compact and high density installation with 2 mm of contact pitch
 - Compliance with e-CON
 - Max. 3 A of current capacity by a pin



■ Ordering information

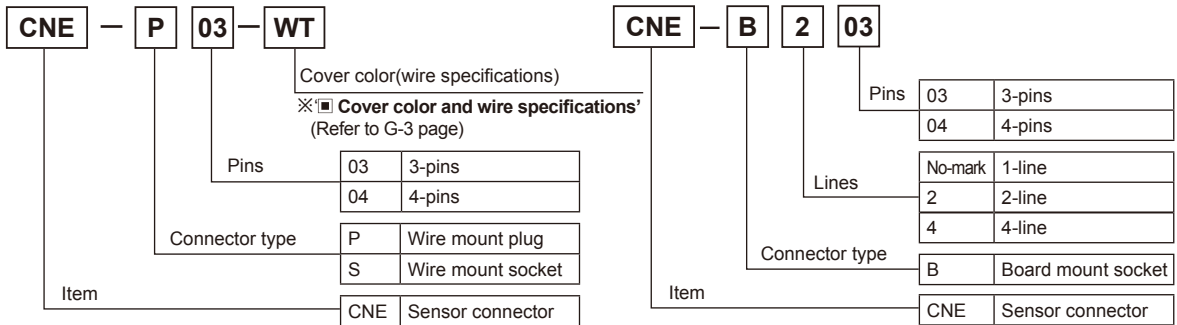

■ Specifications

Type	Wire mount plug	Wire mount socket	Board mount socket
Model	CNE-P □□	CNE-S □□	CNE-B □□
Applica- tion	Connector	Board mount socket/Wire mount socket	Wire mount plug
	Cable	AWG30 to 20(Ø0.6 to Ø2.0)	
	PCB	— Fender plated-through hole, Hole dia.: 1.0mm, PCB thickness : 1.0 to 2.2mm	
Rated voltage	Max. 250VAC/DC		
Rated current	Max. 3.0A		
Temperature	-20 to 85°C(applying 1A), -20 to 75°C(applying 2A), -20 to 60°C(applying 3A)		
Humidity	40 to 80%RH		
Terminal retention	1.4kgf min.		
Pressure strength	• AWG30 : 0.5kgf min. • AWG24 : 0.8kgf min. • AWG20 : 1.0kgf min.		
Extraction	0.49N(50gf)/pin min.		
Insertion	1.96N(200gf)/pin max.		
Dielectric strength	1,000VAC for 1min.(between terminals)		
Insulated resistance	Min. 1,000MΩ(between terminals)		
Contact resistance	Max. 0.05Ω (short-current : 1mA, max. open voltage : 20mV)		
Material	Body : PCABS(UL94V-0), Terminal : C5210(Gold 0.2μm), Case : PC(UL94-V0)		Body : PCABS(UL94-V0), Terminal : C5210(Gold 0.2μm)

Sensor Connector

Cover color and wire specifications

Cover color	3-pin	4-pin	Applied wire specifications	
			Normal cross section area(mm ²)	Cover diameter(mm)
Transparent(WT)	CNE-□03-WT	CNE-□04-WT	0.05 to 0.08 (AWG30 to 28)	∅0.6 to 0.8
Yellow-Green(YG)	CNE-□03-YG	CNE-□04-YG		∅0.8 to 1.0
Violet(VT)	CNE-□03-VT	CNE-□04-VT		∅1.0 to 1.2
Red(RE)	CNE-□03-RE	CNE-□04-RE	0.13 to 0.21 (AWG26 to 24)	∅0.8 to 1.0
Yellow(YW)	CNE-□03-YW	CNE-□04-YW		∅1.0 to 1.2
Orange(OG)	CNE-□03-OG	CNE-□04-OG	0.32 to 0.5 (AWG22 to 20)	∅1.2 to 1.6
Green(GN)	CNE-□03-GN	CNE-□04-GN		∅1.0 to 1.2
Blue(BL)	CNE-□03-BL	CNE-□04-BL		∅1.2 to 1.6
Gray(GY)	CNE-□03-GY	CNE-□04-GY		∅1.6 to 2.0

※ □ : P(Wire mount plug), S(Wire mount socket)

Dimensions

Wire mount plug

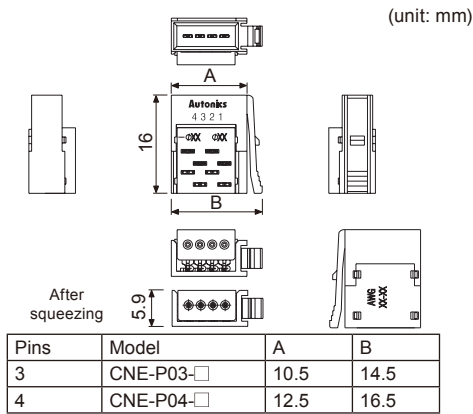

Wire mount socket

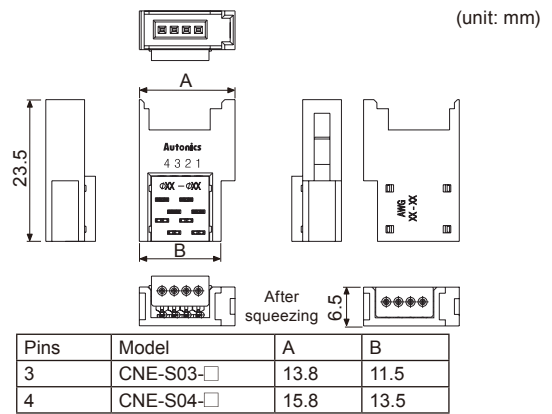

Board mount socket

● CNE-B03(1-line×3-pin)

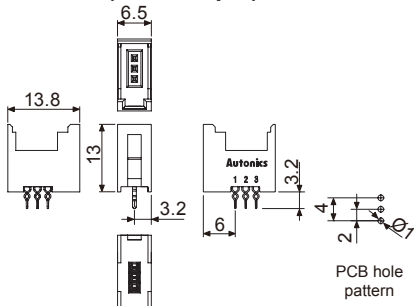

● CNE-B04(1-line×4-pin)

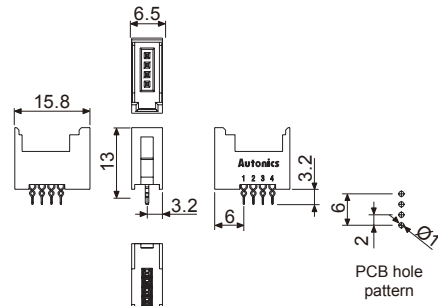

● CNE-B203(2-line×3-pin)

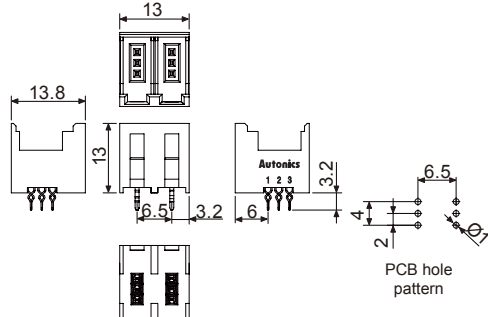

● CNE-B204(2-line×4-pin)

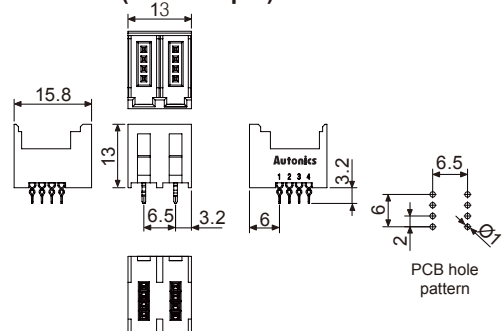

(A) Photo electric sensor

(B) Fiber optic sensor

(C) Door/Area sensor

(D) Proximity sensor

(E) Pressure sensor

(F) Rotary encoder

(G) Connector/Socket

(H) Temp. controller

(I) SSR/ Power controller

(J) Counter

(K) Timer

(L) Panel meter

(M) Tacho/ Speed/ Pulse meter

(N) Display unit

(O) Sensor controller

(P) Switching mode power supply

(Q) Stepper motor& Driver&Controller

(R) Graphic/ Logic panel

(S) Field network device

(T) Software

(U) Other

CNE Series

◎ Board mount socket

(unit: mm)

● CNE-B403(4-line×3-pin)

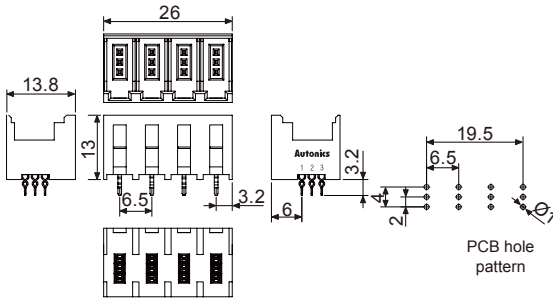

● CNE-B404(4-line×4-pin)

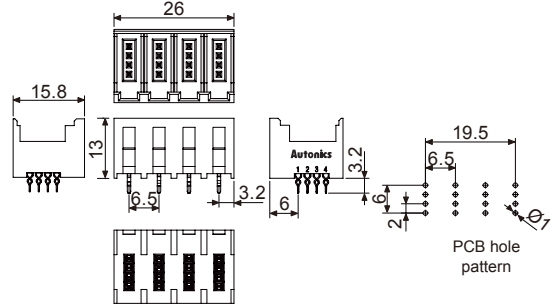

■ How to press sensor connector

1) Select connector.

- Check the wire specifications (conductor section, cover diameter).
- Select the proper color of sensor connector(model) by referring to the below table.

Cover color	Wire mount plug	Wire mount socket	Applied wire specifications	
			Nominal cross section area(mm ²)	Cover diameter(mm)
Transparent(WT)	CNE-P□-WT	CNE-S□-WT	0.05 to 0.08 (AWG30 to 28)	∅0.6 to 0.8
Yellow-Green(YG)	CNE-P□-YG	CNE-S□-YG		∅0.8 to 1.0
Violet(VT)	CNE-P□-VT	CNE-S□-VT		∅1.0 to 1.2
Red(RE)	CNE-P□-RE	CNE-S□-RE	0.13 to 0.21 (AWG26 to 24)	∅0.8 to 1.0
Yellow(YW)	CNE-P□-YW	CNE-S□-YW		∅1.0 to 1.2
Orange(OG)	CNE-P□-OG	CNE-S□-OG	0.32 to 0.5 (AWG22 to 20)	∅1.2 to 1.6
Green(GN)	CNE-P□-GN	CNE-S□-GN		∅1.0 to 1.2
Blue(BL)	CNE-P□-BL	CNE-S□-BL	0.32 to 0.5 (AWG22 to 20)	∅1.2 to 1.6
Gray(GY)	CNE-P□-GY	CNE-S□-GY		∅1.6 to 2.0

※□: Number of pins (03: 3-pin, 04: 4-pin)

※The proper sensor connector may be different by conductor of wire.

※Cover diameter of applied wire at connector (at translucent part) and AWG number of body backside are marked.



2) Insert wires.

- Check the pin number and insert wires at the insertion part of the cover.
- Check the wires are inserted at the end of cover.

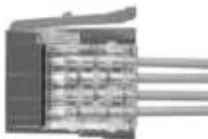

3) Squeeze the connector.

- Insert the cover to the body with tools (press fitting pliers, etc).
- ※Squeeze it with tools at the side direction as below figure.



4) Check the cover.

- Check the cover which has gaps and is even with the cover.



Wrong (1)

Wrong (2)

Not enough cover insertion.

Not enough cover insertion.

※Press the part of arrows again.